

Data Sheet



Article number: 2307083264

Description: E+G Direct drive position indikator
DD52R-FN-0006.0-S-C3 (Grey)

Measures

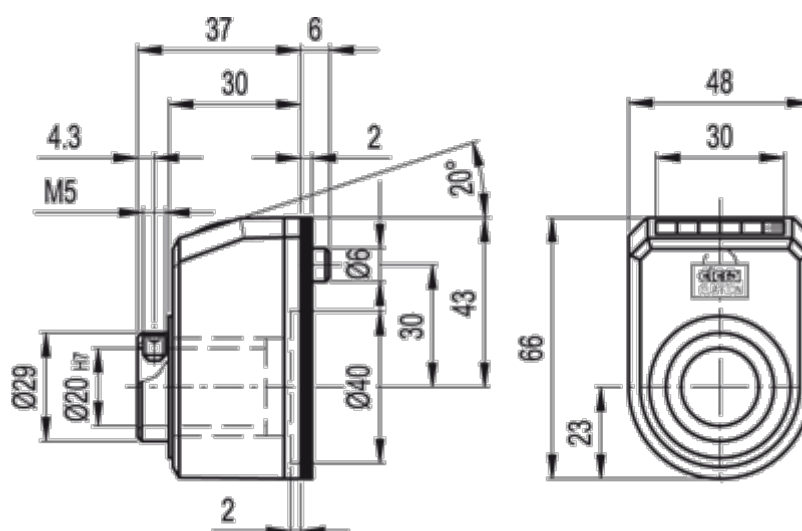

Max rpm = 415